

# QUADRUS EZ™

## Quadrus EZ™ is a true out-of-the-box solution for decoding linear, stacked, and 2D bar code symbols.

Specializing in reading low contrast applications, Quadrus EZ™ decodes symbols directly marked by dot peen, laser etch, chemical etch, ink jet, and thermal transfer that are applied to materials such as metals, plastic, rubber, and glass. Quadrus EZ™ provides the read performance of a vision system in an easy-to-use smart camera device.

### Compared to vision systems, Quadrus EZ™:

- Is a one-piece solution including illumination, camera, and decoding platform
- Is easy to use, no pc or external illumination required
- Is more cost effective

### Compared to laser bar code scanners Quadrus EZ™:

- Reads 2D symbols
- Has omni directional reading
- Decodes low contrast etched or dot peen symbols

## DYNAMIC 1D & 2D BAR CODE READER

### Ease of Use:

Designed into every aspect of Quadrus EZ™, initial set up can be done in seconds.

### A 2-step setup:

1. Position symbol using the "X" pattern.
2. Push the EZ™ button to read.

### Field of View Locator & Good Read Indicator:

A red "X" identifies the field of view center, allowing fast and accurate placement. After the symbol has been targeted, Quadrus EZ™ emits a bright green flash (visible from all angles) signaling a successful read.



### EZ button:

- Enables locator pattern
- Enables the calibrate mode
- Enables read rate mode
- Defaults the reader

This simplifies initial set up process and allows the reader to be configured directly on the line, without the aid of a PC.

### Extensive Focal Range:

Quadrus EZ™ offers four optical versions, factory adjustable from 2 to 10 inches (50.8 to 254 mm).

Additional focal points and field of views can be achieved by using an analog RS-170 progressive scan camera to capture and receive images.

### Dynamic Reading:

High decode speeds and superior light collection allow the Quadrus EZ™ to meet the needs of applications that have line speeds of several meters a second.

### Ethernet Connectivity:

Embedded Ethernet is an option available for high speed data and image transfer.

### 2D Symbol Validation:

Quadrus EZ™ provides 17 different validation parameters that are useful in gauging readability. Some key parameters are:

- Symbol contrast
- Axial non-uniformity
- Center shape/offset
- Dot quality
- Print growth
- Cell fill
- Angle of distortion

### Video Input/Output:

Quadrus EZ™ offers optional video input and output ports. This allows standard analog RS-170 cameras to be used, and a live video feed to view images. Adding a camera can expand optical flexibility to increase focal ranges, or be used where there may be physical size constraints.

### Symbologies:

Quadrus EZ™ reads various 2D, stacked and linear symbologies. Some examples include:







#### 2D Symbologies

- Data Matrix (ECC 0-200) 
- QR Code 

#### Stacked Symbology

- PDF417 
- RSS (Stacked, Composite) 
- Micro PDF 

#### Linear Bar Code

- BC412 
- Code 39 
- Code 128 
- I-2 of 5 
- UPC/EAN 
- Pharmacode 

Codes depicted above are for display purposes only. For a sample packet, contact Microscan, info@microscan.com.



Microscan's ESP Setup program is Windows-based and used for configuring and testing Quadrus EZ™.

# MICROSCAN®

# QUADRUS EZ™ DYNAMIC 1D & 2D BAR CODE READER

## SPECIFICATIONS AND OPTIONS

### MECHANICAL

**Height:** 2.25" (57 mm)  
**Width:** 2.5" (64 mm)  
**Depth:** 4.2" (107 mm)  
**Weight:** 12 oz. (340 g)

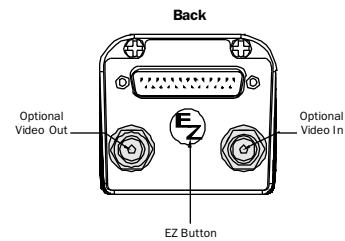
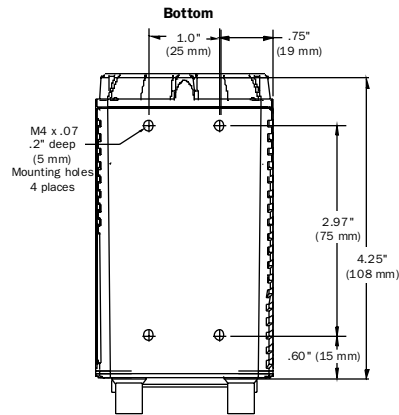
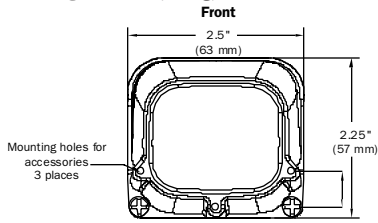

### ENVIRONMENTAL

**Enclosure:** IP65 (standard unit)  
**With Video I/O Option:** IP55  
**Operating Temperature:** 0° to 43°C (32° to 109°F), if mounted on a Microscan stand. If mounted on non-metal surface, maximum operating temperature is 40°C (104°F)  
**Storage Temperature:** -50° to 75° C (-58 to 167°F)  
**Humidity:** up to 90% (non-condensing)

### EMISSIONS/IMMUNITY

**ITE Disturbances:** EN55022: 1998 (radiated and conducted). Class A  
**General Immunity:** EN55024:1998 (residential)  
**Heavy Industrial Immunity:** EN61000-6-2:1999

### LIGHT SOURCE

**Type:** High output LEDs

### LIGHT COLLECTION OPTIONS

Progressive scan, square pixel.  
 Software adjustable shutter speed, electronic mechanism  
**CCD Array:** 659 x 494 pixels  
**CMOS Array:** 640 by 480 pixels

### SYMBOLGY TYPES

**2D Symbolgies:**  
 Data Matrix (ECC 0-200), QR Code  
**Stacked Symbolgies:** PDF417, Micro PDF417, RSS (Composite & Stacked)  
**Linear Bar Codes:** Code 39, Code 128, IBM BC412, I2 of 5, Pharmacoce, UPC/EAN

### FOUR OPTICAL VERSIONS

Medium Density CCD option shown (right)  
 For more information on Quadrus EZ's other optical versions including Narrow, Wide, and Extra Wide, please contact Microscan.

### MEASUREMENT

Shown in inches (mm)

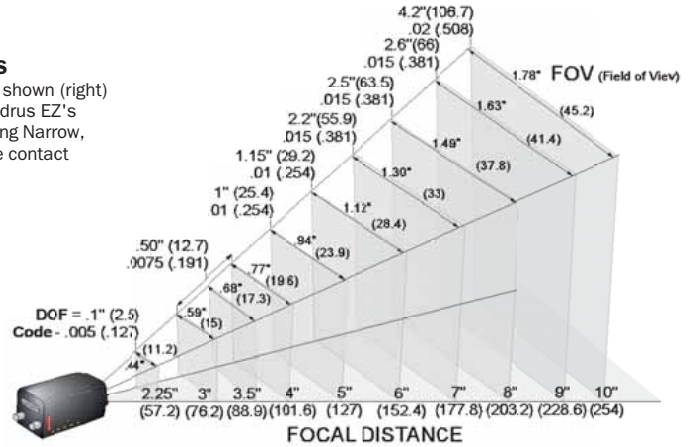

### STANDARD OFFERING

#### CONNECTORS/PIN ASSIGNMENTS

**Host Connector:** 25-pin D-subminiature plug

Pin No.	Host RS232	Host & Aux RS232	Host RS422/485	In/Out
1	Chassis ground <sup>a</sup>			
2	TxD			Out
3	Rx D			In
4	RTS	Tx D		Out
5	CTS	Rx D		In
6	Output 1 (+)			Out
7	Signal Ground <sup>b</sup>			
8	Output 2 (+)			Out
9	Trigger (-)			In
10	Trigger (+)			In
11	Default configuration <sup>c</sup>			In
12	Input 1 (+)			In
13		RxD (+)		In
14		TxD (-)		Out
15	Output 3 (+)			Out
16		RxD (-)		In
17	Power Ground <sup>d</sup>			
18	Power +10 to 28 VDC			In
19		TxD +		Out
20	Output 1 (-)			Out
21	Output 2 (-)			Out
22	Output 3 (-)			Out
23	Input 1 (-)			In
24	New master (-)			In
25	New master (+)			In

<sup>a</sup>Chassis ground: Used to connect chassis body to earth ground only. Not to be used as power or signal return.

<sup>b</sup>Signal ground: Used for communication and signal line grounds only. Not to be used as power or chassis return.

<sup>c</sup>The default is activated by connecting pin 11 to ground pin 7.

<sup>d</sup>Power ground: Used for power return only.

Caution: If using your own power supply, verify correct connection of power and ground lines. Incorrect connections or use of "Chassis ground," "Power ground," and "Signal ground" lines could cause equipment or software failure.

### ETHERNET OPTION

**Host Connector:** Pins Utilized

Pin No.	Function	In/Out
13	Ethernet RxD (+)	In
14	Ethernet RxD(-)	Out
16	Ethernet Tx D (-)	In
19	Ethernet Tx D (+)	Out

### VIDEO INPUT (Option)

**Signal System:** Progressive scan  
**Number of Scanning Lines:** 525 lines/non-interlaced  
**Input:** Analog 1 Vp-p

### VIDEO OUTPUT (Option)

**Signal System:** EIA  
**Number of Scanning Lines:** 525 lines/ 2:1 interlaced  
**Output:** Analog 1 Vp-p/75 ohm

### READ PARAMETERS

**Pitch:** ±30° **Skew:** ±30° **Tilt:** 360°  
**Decode Rate:** Up to 60 decodes per second  
**Focal Range:** 2 to 10 inches (factory adjustable)

### INDICATORS

**LEDs:** Read Performance, Power, Read Status, and Network Status  
**Beeper:** Good read, match/mismatch, no read, serial command confirmation, on/off

### COMMUNICATION PROTOCOLS

**Standard Interface:** RS-232, RS-422, RS-485, RS-232, Daisy Chain  
**Optional Interface:** Ethernet

### ELECTRICAL

**Power Requirements:** Input, 10 to 28 VDC, 200 mV p-p max ripple, 270 mA at 24 VDC (typ.- CMOS), 333 mA at 24 VDC (typ.-CCD).  
**Trigger, New Master, Input 1:** (Optoisolated) 5 to 28 VDC rated, (12mA at 24 VDC).  
**Outputs 1/2/3:** (Optoisolated) 1 to 28 VDC rated, (I<sub>CC</sub> < 100mA at 24 VDC, current limited by user).

### SAFETY CERTIFICATIONS

Designed for: FCC, CE, cUL, UL, BSMI

### ISO CERTIFICATION

Issued by RWTüV, USA Inc.  
 ISO 9001:2000 - Cert No. 03-1212

©2004 Microscan Systems, Inc.

**Specification, 03/04-Base E**  
 Specifications subject to change.

Product specifications are given for typical performance at 25° Celsius (77° Fahrenheit) using grade A labels. Some performance characteristics may vary at high temperatures or other environmental extremes.  
**Warranty** — One year limited warranty on parts and labor. Extended warranty available.

# MICROSCAN

### Microscan Systems, Inc.

Tel 425 226 5700/ 800 251 7711  
 Fax 425 226 8250

### Microscan Europe

Tel 31 172 423360/ Fax 31 172 423366

### Microscan Asia Pacific R.O.

Tel 65 6846 1214 / Fax 65 6846 4641

[www.microscan.com](http://www.microscan.com)

**Tech Support:** [helpdesk@microscan.com](mailto:helpdesk@microscan.com)

**Product Information:** [info@microscan.com](mailto:info@microscan.com)

For more details and virtual product tour go to [www.quadrus-ez.com](http://www.quadrus-ez.com).